

Optie 000.003: uitbouw 1,2m achtergevel

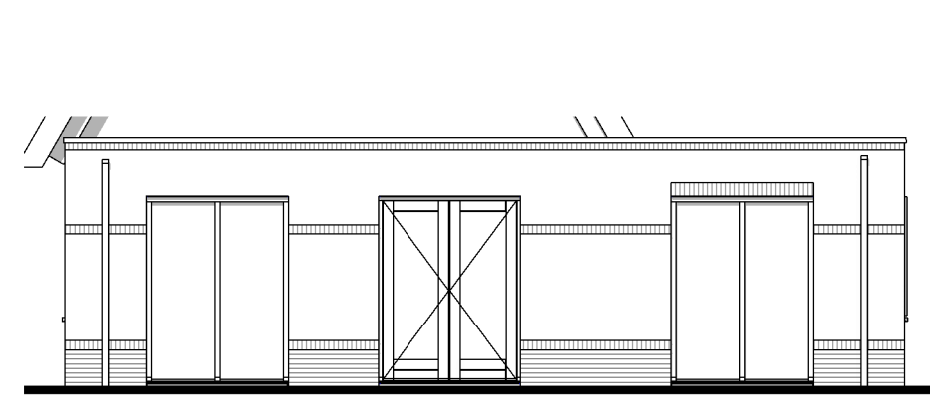

Achtergevel

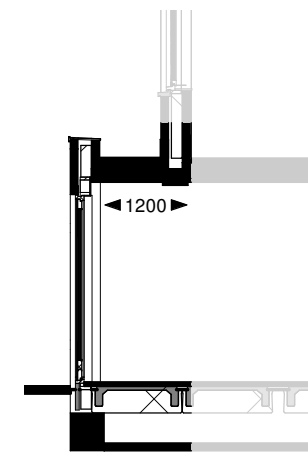

Doorsnede

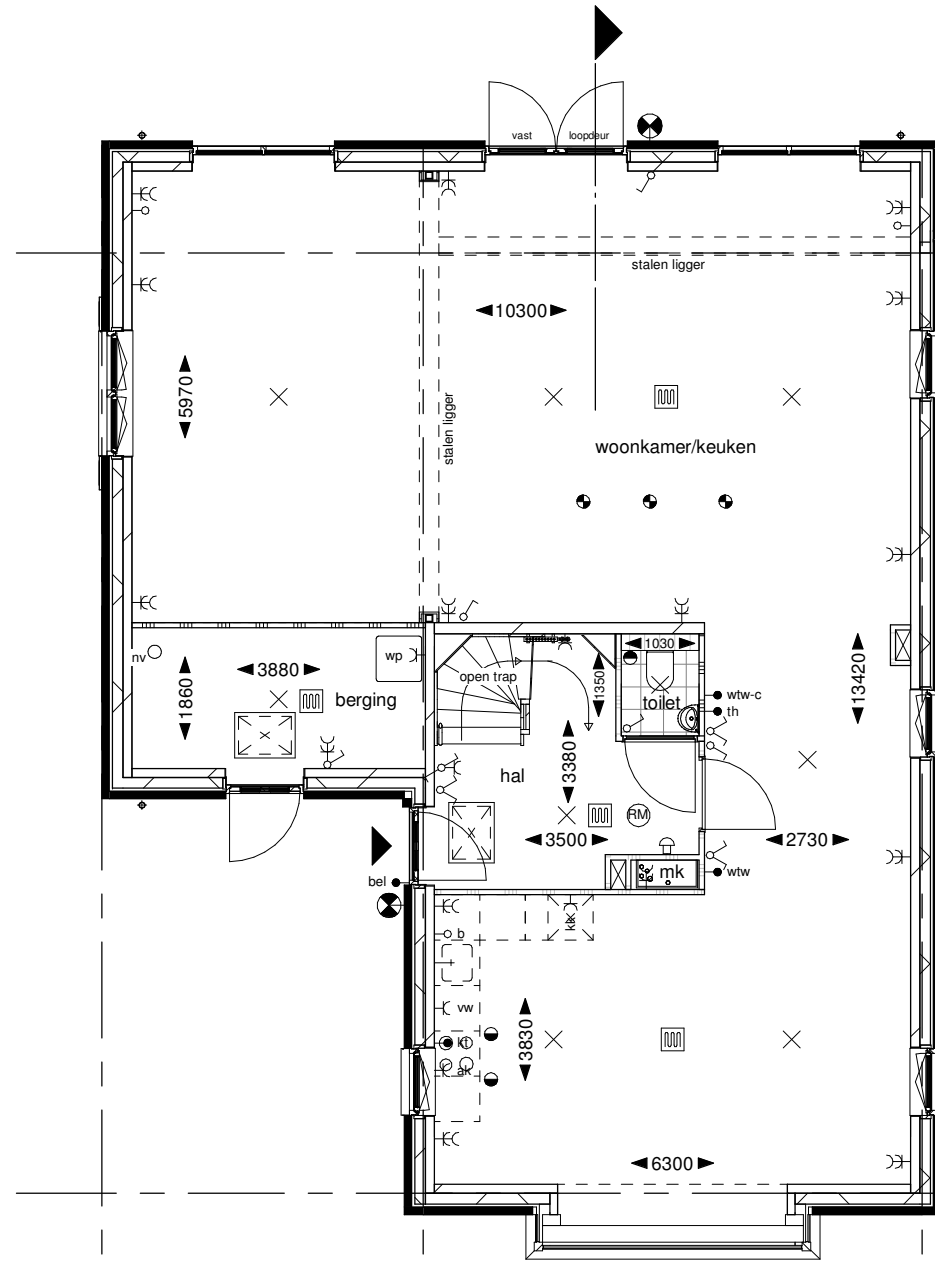

Begane grond

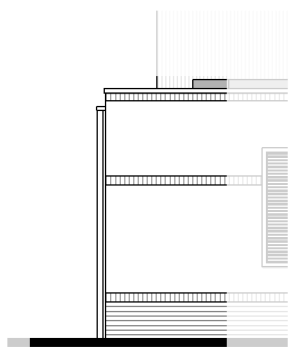

Zijgevel

Optie 000.004: uitbouw 2,4m achtergevel

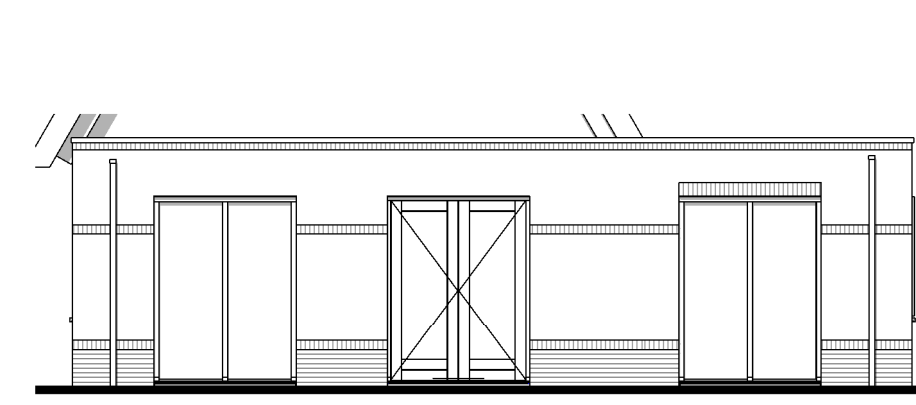

Achtergevel

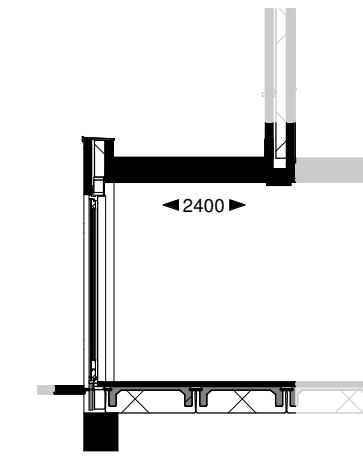

Doorsnede

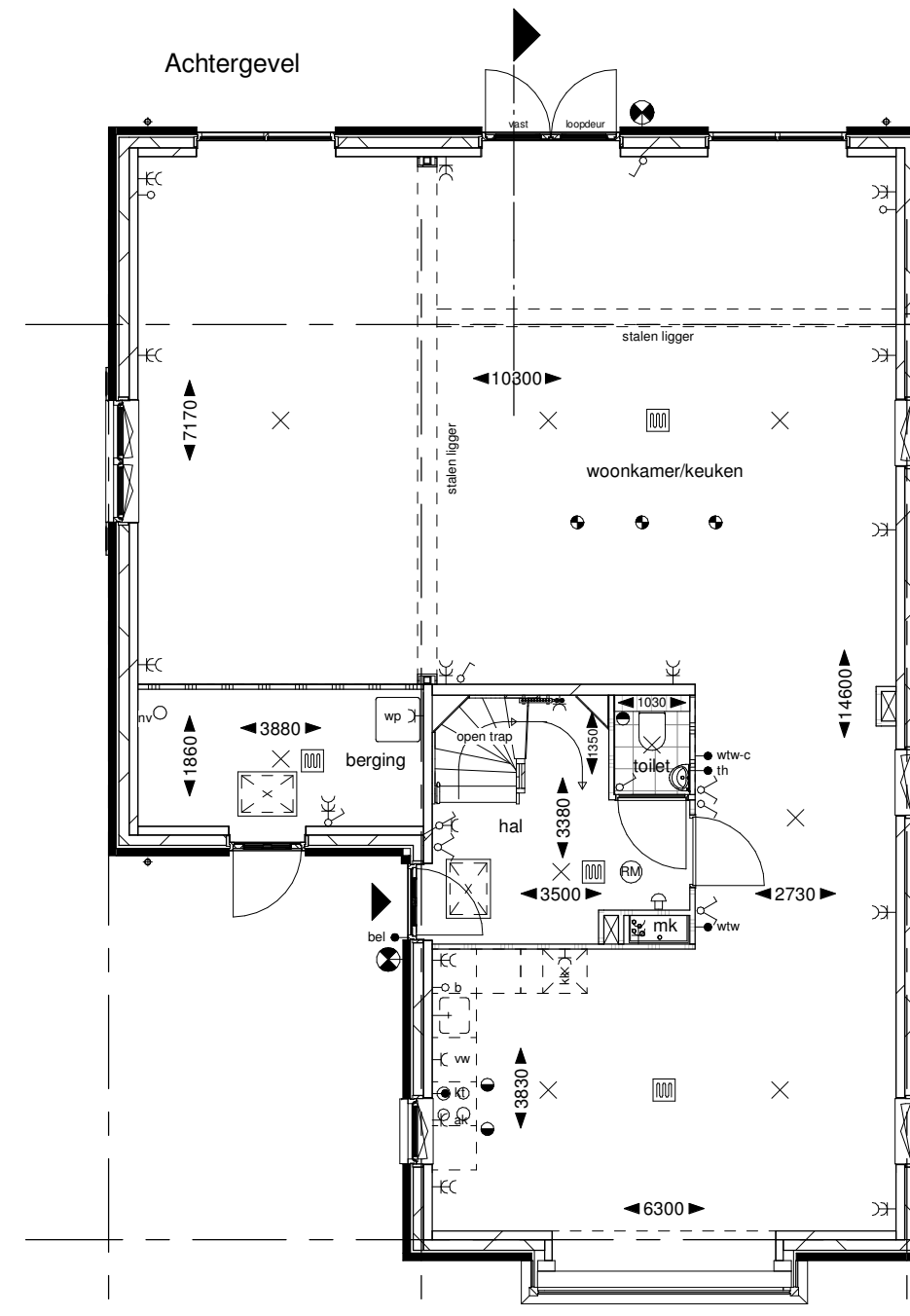

Begane grond

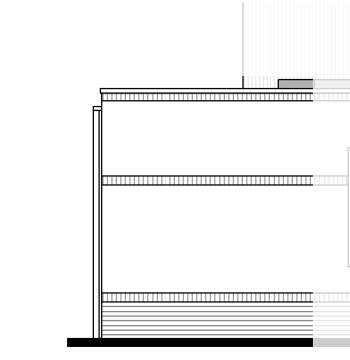

Zijgevel

Optie 000.056: dakraam zijgevel

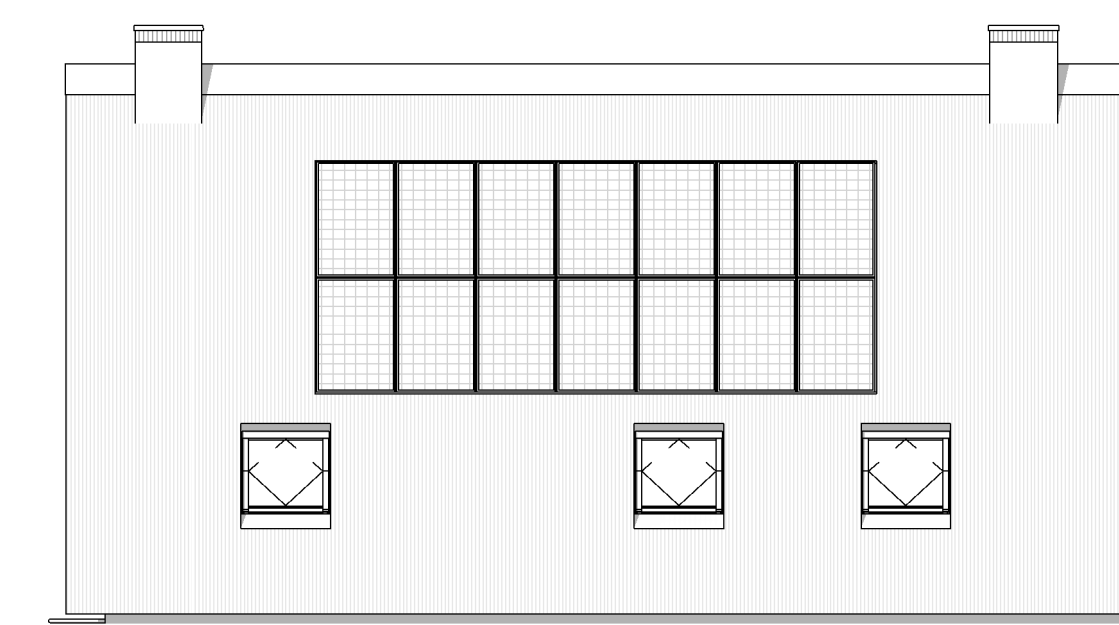

Zijgevel

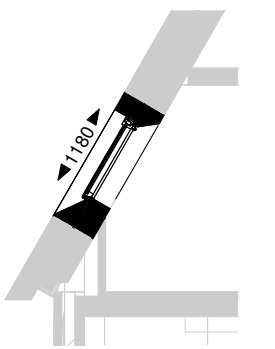

Doorsnede

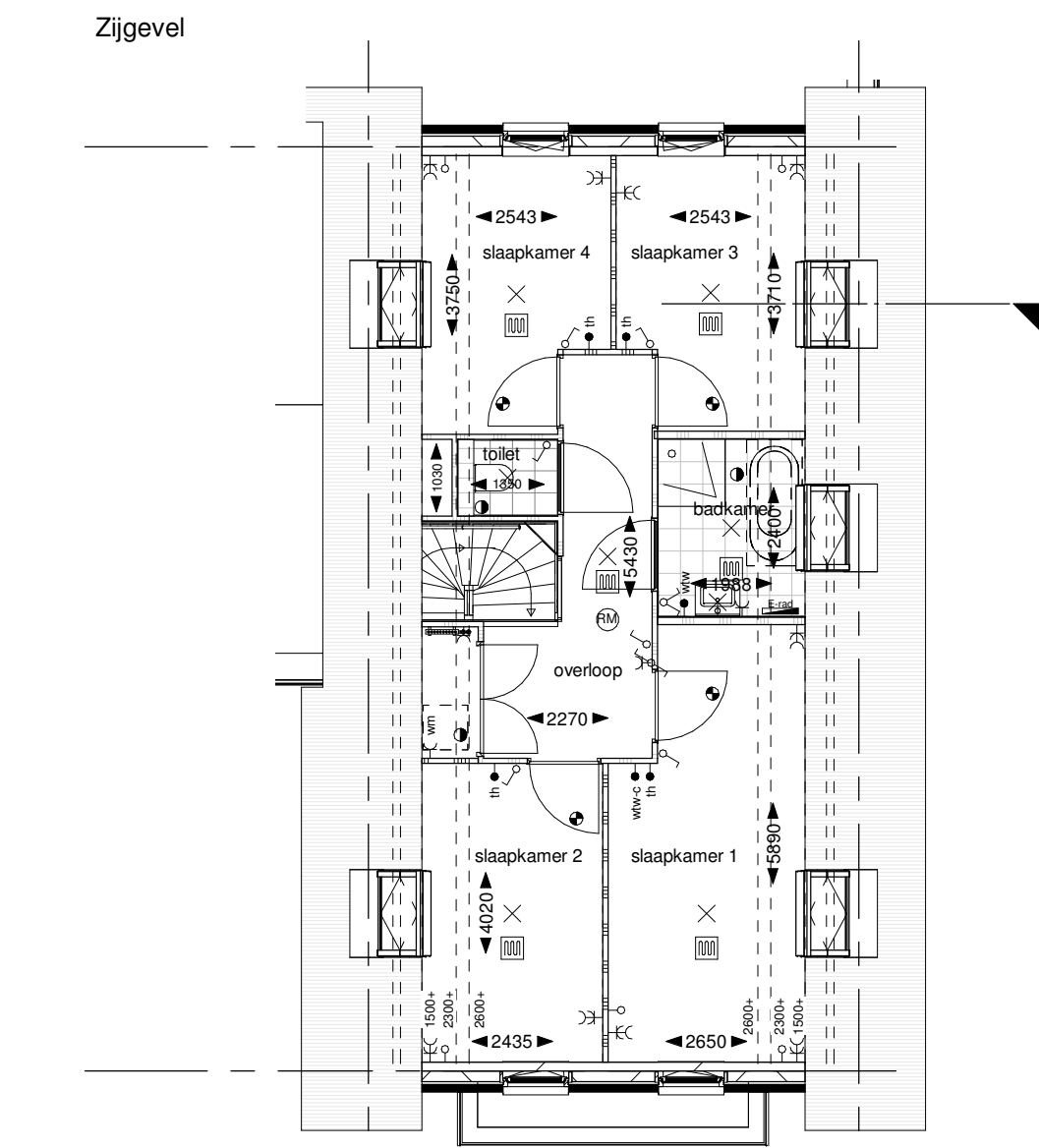

Eerste verdieping

Optie 200.014: werkkamer begane grond

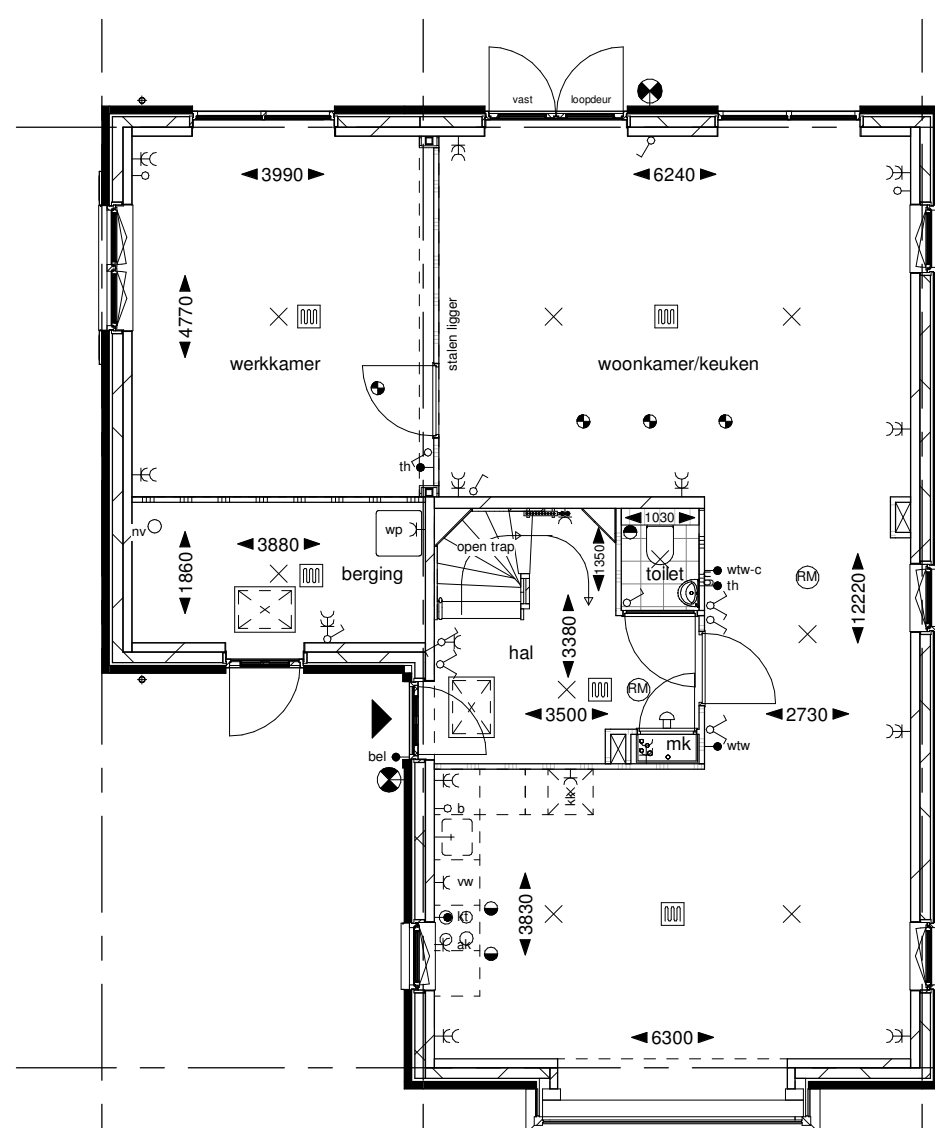

Begane grond

Het metselwerk en kozijnkleuren worden uitgevoerd volgens de tekeningen van de bouwaanvraag. Vergunningsvrije opties vallen buiten deze aanvraag.



opdrachtgever:  
Vink Ontwikkeling  
project:  
't Lage Moordrecht  
bladomschrijving:  
Opties  
Blok 5/ bnr. 8

schaal: 1:100  
formaat: A1  
datum: 08-04-2022

A 22-06-2022  
B  
C

werknr:  
V2020-73  
bladnr:  
VT-O-04